



Mallas

Protección

Se recomiendan para instalaciones en las cuales sea necesario proteger el interior del equipo, el recinto y sobre todo, evita el contacto directo con piezas en movimiento; salvaguardando la integridad de las personas y maquinaria que se encuentre a su alrededor.

Gamas aplicables

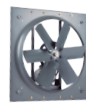

HIB-T



HGB-T



TAT



TGT



CL



CM



CR

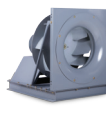

BNC



BIL

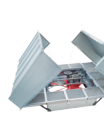

DX

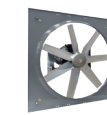

HXA-P



HXBT



CEB-T



DA

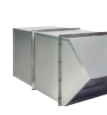

WX

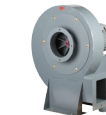

CSB-T

Características

- Materiales de fabricación: lámina desplegada o alambre pulido.
- Diseño realizado de acuerdo al equipo a utilizar (axial, centrífugo, plenum, tubular, etc.)
- Los modelos circulares pueden ser fabricados con lámina desplegada galvanizada o alambre con recubrimiento, galvanizado, tropicalizado o electroforético.
- Sistema de sujeción removible.

Tipos de mallas

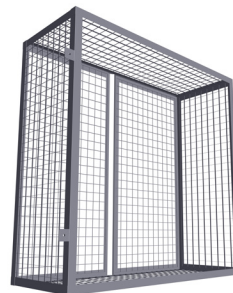
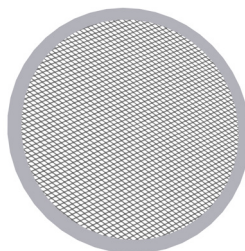
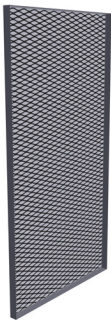



Dimensiones

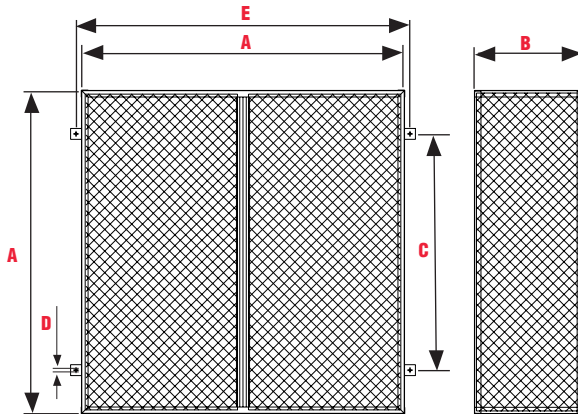

Para los equipos:

HXB-T · HIB-T · HGB-T · HXA-P

Dimensiones en mm
Barrenos de diámetro 3/8"

Modelo	M-400	M-500	M-630	M-800	M-1000	M-1250	M-1500	M-1800
A	590	720	900	1120	1290	1560	1860	2150
B	250	250	350	420	5	500	630	800
C	450	550	600	800	800	800	1600	1760
D	10	10	10	10	10	10	10	10
E	690	820	1000	1220	1390	1660	1960	2045

Dimensiones

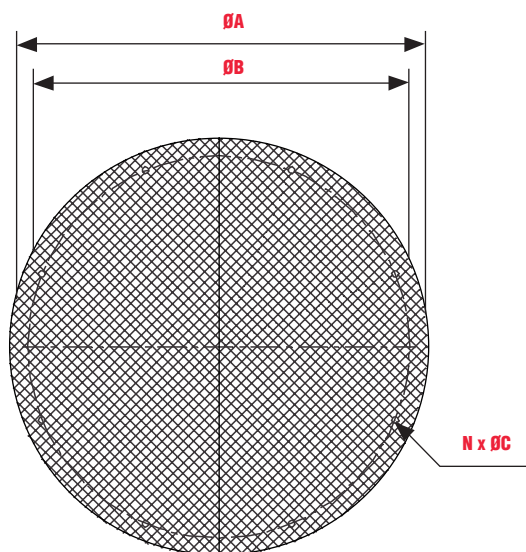

Para los equipos:

CM

Modelo	ØA		ØB		ØC		N
	mm	in	mm	in	mm	in	
CM-250	306	12 1/6	286	11 1/4	7.9	5/16	6
CM-280	348	13 11/16	322	12 11/16	7.9	5/16	6
CM-315	382	15 1/16	355	14	7.9	5/16	8
CM-355	422	16 5/8	395	15 9/16	7.9	5/16	8
CM-400	466	18 3/8	438	17 1/4	7.9	5/16	8
CM-450	524	20 5/8	487	19 3/16	7.9	5/16	8
CM-500	574	22 5/8	542	21 5/16	7.9	5/16	8
CM-560	634	24 15/16	606	23 7/8	9.5	3/8	8
CM-630	704	27 11/16	673	26 1/2	9.5	3/8	8
CM-710	784	30 7/8	750	29 1/2	11.5	7/16	8
CM-800	872	34 5/16	800	31 1/2	11.5	7/16	12
CM-900	972	38 1/4	937	36 7/8	11.5	7/16	12
CM-1000	1078	42 7/16	1043	41 1/16	11.5	7/16	12
CM-1120	1206	47 1/2	1108	43 5/8	13	1/2	14
CM-1250	1340	52 3/4	1257	49 1/2	13	1/2	14
CM-1400	1500	59	1395	55	13	1/2	14

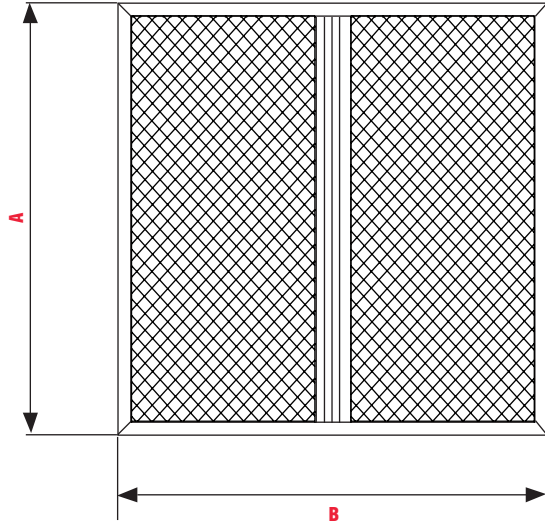
Dimensiones

Para los equipos:
WX

Dimensiones en mm

Modelo	A	B
WX-500	510	510
WX-630	727	727
WX-800	927	927
WX-1000	1097	1097
WX-1250	1385	1385
WX-1500	1689	1689

Dimensiones en in

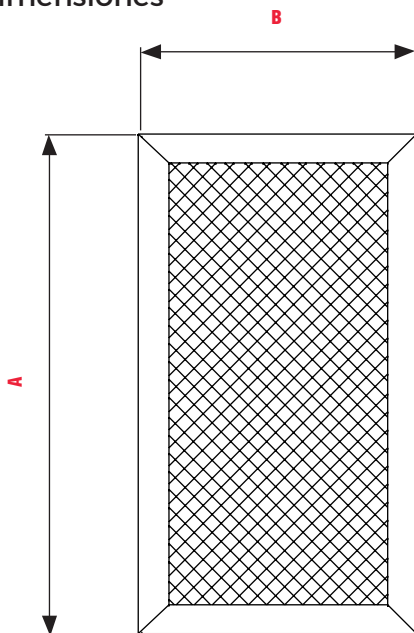
Modelo	A	B
WX-500	21 1/4	21 1/4
WX-630	28 5/8	28 5/8
WX-800	36 1/2	36 1/2
WX-1000	43 3/16	43 3/16
WX-1250	54 1/2	54 1/2
WX-1500	66 1/2	66 1/2

Dimensiones

Para los equipos:
CM

Modelo	A		B	
	mm	in	mm	in
CM-250	325	12 13/16	182	7 3/16
CM-280	366	14 7/16	202	7 15/16
CM-315	409	16 1/8	225	8 7/8
CM-355	458	18 1/16	249	9 13/16
CM-400	511	20 1/8	275	10 13/16
CM-450	573	22 9/16	310	12 3/16
CM-500	643	25 5/16	347	13 11/16
CM-560	720	28 3/8	388	15 1/4
CM-630	806	31 3/4	435	17 1/8
CM-710	906	35 3/4	481	18 7/8
CM-800	1014	40	535	21 1/8
CM-900	1138	44 3/4	597	23 4/8
CM-1000	1274	50 1/4	665	26 1/8
CM-1120	1526	60	845	33 1/4
CM-1250	1625	64	915	36
CM-1400	1905	75	1028	40 1/2
CM-1600	2022	79 5/8	1061	41 3/4
CM-1800	2274	89 1/2	1193	46 15/16
CM-2000	2562	100 7/8	1325	52 3/16